

Interface Relays

RV8H



Ultra-slim interface relays suitable for high density mounting



• See website for details on approvals and standards.

Screw and spring clamp terminals

Marking plate can be installed on the release lever



Only 70mm from the DIN rail

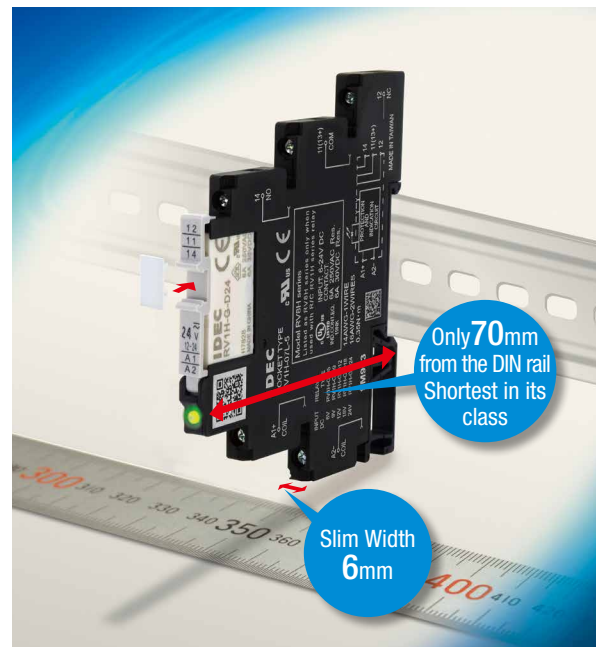

Easy wiring, simple maintenance

LED indicator.
Release lever for easy locking and removal of relays.

6A contact capacity in the slim housing

Gold-clad contacts for high contact reliability

RV8H Interface Relays

Space-saving 6mm width suitable for high density mounting.





- APEM
- Switches & Pilot Lights
- Control Boxes
- Emergency Stop Switches
- Enabling Switches
- Safety Products
- Explosion Proof
- Terminal Blocks

Relays & Sockets

- Circuit Protectors
- Power Supplies
- LED Illumination
- Controllers
- Operator Interfaces
- Sensors
- AUTO-ID

Interface Relays

Package Quantity: 1

Contact Arrangement	Coil Voltage	Part No.	
		Screw Terminal	Spring Clamp Terminal
			
SPDT	6V DC	RV8H-L-D6	RV8H-S-D6
	9V DC	RV8H-L-D9	RV8H-S-D9
	12V DC	RV8H-L-D12	RV8H-S-D12
	18V DC	RV8H-L-D18	RV8H-S-D18
	24V DC	RV8H-L-D24	RV8H-S-D24
	12V AC/DC	RV8H-L-AD12	RV8H-S-AD12
	18V AC/DC	RV8H-L-AD18	RV8H-S-AD18
	24V AC/DC	RV8H-L-AD24	RV8H-S-AD24
	48V AC/DC	RV8H-L-AD48	RV8H-S-AD48
	60V AC/DC	RV8H-L-AD60	RV8H-S-AD60
	110-125V AC/DC	RV8H-L-AD110	RV8H-S-AD110
	220-240V AC/DC	RV8H-L-AD220	RV8H-S-AD220



- Relays
- Sockets
- DIN Rail Products
- RJ
- RU
- RV8H
- RL



RV8H Interface Relays

Accessories

Relay / Socket

Package Quantity: 1

Screw Terminal		
Interface Relay Complete Part No.	Applicable Socket Part No.	Applicable Relay Part No.
		
RV8H-L-D6	SV1H-07L-5	RV1H-G-D5
RV8H-L-D9		RV1H-G-D9
RV8H-L-D12		RV1H-G-D12
RV8H-L-D18		RV1H-G-D18
RV8H-L-D24		RV1H-G-D24
RV8H-L-AD12	SV1H-07L-1	RV1H-G-D12
RV8H-L-AD18		RV1H-G-D18
RV8H-L-AD24		RV1H-G-D24
RV8H-L-AD48	SV1H-07L-2	RV1H-G-D48
RV8H-L-AD60		RV1H-G-D60
RV8H-L-AD110	SV1H-07L-3	RV1H-G-D60
RV8H-L-AD220	SV1H-07L-4	RV1H-G-D60

Spring Clamp Terminal		
Interface Relay Complete Part No.	Applicable Socket Part No.	Applicable Relay Part No.
		
RV8H-S-D6	SV1H-07LS-5	RV1H-G-D5
RV8H-S-D9		RV1H-G-D9
RV8H-S-D12		RV1H-G-D12
RV8H-S-D18		RV1H-G-D18
RV8H-S-D24		RV1H-G-D24
RV8H-S-AD12	SV1H-07LS-1	RV1H-G-D12
RV8H-S-AD18		RV1H-G-D18
RV8H-S-AD24		RV1H-G-D24
RV8H-S-AD48	SV1H-07LS-2	RV1H-G-D48
RV8H-S-AD60		RV1H-G-D60
RV8H-S-AD110	SV1H-07LS-3	RV1H-G-D60
RV8H-S-AD220	SV1H-07LS-4	RV1H-G-D60

Specifications

Part No.		RV8H-L (Screw Terminal)	RV8H-S (Spring Clamp Terminal)
Number of Poles		1-pole	
Contact Configuration		SPDT	
Contact Material		Silver alloy (gold-plated)	
Degree of Protection		Relay: IP67, Socket: IP20 (IEC 60529)	
Contact Resistance (initial value)		100mΩ maximum	
Operate Time		15ms maximum	
Release Time		20ms maximum	
Insulation Resistance		1,000MΩ minimum (500V DC megger)	
Dielectric Strength	Between contact and coil	4,000V AC, 1 minute	
	Between contacts of the same pole	1,000V AC, 1 minute	
Vibration Resistance	Operation extremes	10 to 55 Hz, amplitude 0.5mm (NO contact), 0.2mm (NC contact)	
	Damage Limits	10 to 55 Hz, amplitude 0.5mm (NO contact), 0.2mm (NC contact)	
Shock Resistance	Operation extremes	49 m/s ² (NO contact), 29.4 m/s ² (NC contact)	
	Damage Limits	980 m/s ²	
Electrical Life (rated load)		30,000 operations minimum (NO contact), 10,000 operations minimum (NC contact) (250V AC/30V DC, 6A resistive load, operation frequency 1,800 operations per hour)	
Mechanical Life (no load)		10 million operations minimum (operation frequency 18,000 operations/hour)	
Operating Temperature		RV8H-*-D6, D9, D12, D18, D24, AD12, AD18, AD24, AD48, AD60: -40 to +70°C (no freezing) RV8H-*-AD110, AD220: -40 to +55°C (no freezing)	
Operating Humidity		5 to 85% RH (no condensation)	
Storage Temperature		-40 to +85°C (no freezing)	
Storage Humidity		5 to 85% RH (no condensation)	
Weight (approx.)		30g	26g

Approval Ratings

UL and c-UL Ratings

Voltage	Resistive	Inductive
250V AC	6A	B300/R300
30V DC	6A	(pilot duty)

VDE Ratings (RV1H relay only)

Voltage	Resistive
250V AC	6A
30V DC	6A

Contact Ratings

Allowable Contact Power		Rated Load			Allowable Switching Current	Allowable Switching Voltage	Minimum Applicable Load
Resistive Load	Inductive Load	Voltage	Resistive Load	Inductive Load			
1,500VA AC 180W DC	B300: AC 360 VA R300: DC 28 VA (pilot duty)	250V AC 30V DC	6A 6A	B300: 240V AC 1.5A R300: 250V DC 0.11A (pilot duty)	6A	400V AC 125V DC	6V DC, 10 mA (reference value)

Coil Ratings

Rated Voltage (V)	Coil Voltage Code	Rated Current (mA) ±15% (at 23°C) (*1)	Coil Resistance (Ω) ±15% (at 23°C) (*1)	Impedance (Ω) ±15% (at 23°C) (*1)	Operating Characteristics (against rated values at 23°C)			Power Consumption	
					Maximum Allowable Voltage	Minimum Pickup Voltage	Dropout Voltage		
DC	6V DC	D6	35	170	110%	90% maximum	7% minimum	0.21	
	9V DC	D9	18.6	485				0.2	
	12V DC	D12	14.6	820				0.25	
	18V DC	D18	11.6	1,550				0.2	
	24V DC	D24	10.6	2,270				0.25	
AC/DC	12V AC/DC	AD12	15.5	800				755	0.2
	18V AC/DC	AD18	13.3	1,345				1,365	0.25
	24V AC/DC	AD24	13.7	1,790				1,730	0.33
	48V AC/DC	AD48	4.0	12,230				11,880	0.2
	60V AC/DC	AD60	3.4	17,910				17,600	0.5
	110-125V AC/DC	AD110	3.4-3.9	32,450-32,900	31,790-31,890	0.85			
220-240V AC/DC	AD220	3.3-3.6	65,940-68,570	65,670-66,070					

*1) D12 and below: ±10%

Accessories

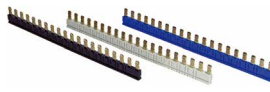
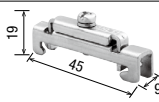
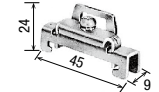
Shape	Material	Part No.	Package Quantity	Note (dimensions in mm.)
	PBT plastic (white)	SV9Z-PW10	1	No marking
 Rated current: 6A (*2)	Brass (nickel-plated) with polyamide sheath Approx. 6g	SV9Z-J20*	10	Specify a color code in place of * in the Part No. B: black W: gray S: blue Can be cut to required length. No. of points: 20
DIN Rail Spacer	Polyamide (gray)	SV9Z-SA2W	1	Used for adjusting spacing between sockets and to prevent the ends of jumpers from exposing.
DIN Rail (*3)	Aluminum, approx. 200g	BAA1000PN10	10	1m long 35mm wide
End Clip (*3)	Zinc-plated steel Approx. 15g	BNL5PN10	10	
		BNL6PN10		

*2) Ensure that the total current to the jumper does not exceed the rated current.

*3) See H-071 for DIN rail products.

APEM

Switches & Pilot Lights

Control Boxes

Emergency Stop Switches

Enabling Switches

Safety Products

Explosion Proof

Terminal Blocks

Relays & Sockets

Circuit Protectors

Power Supplies

LED Illumination

Controllers

Operator Interfaces

Sensors

AUTO-ID

Relays

Sockets

DIN Rail Products

RJ

RU

RV8H

RL

RV8H Interface Relays

Dimensions

All dimensions in mm.

Screw Terminal

RV8H-L

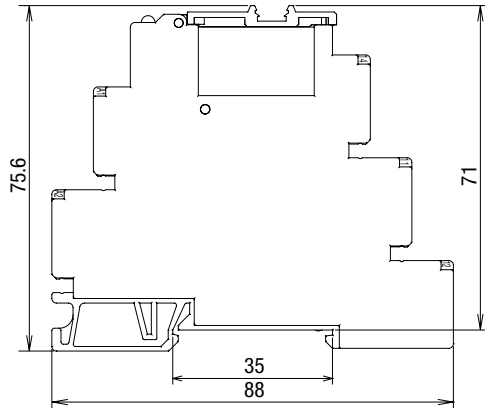

Spring Clamp Terminal

RV8H-S

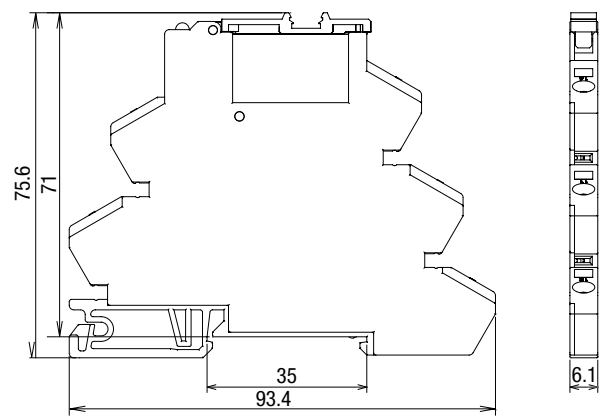

Terminal Arrangement

AC/DC

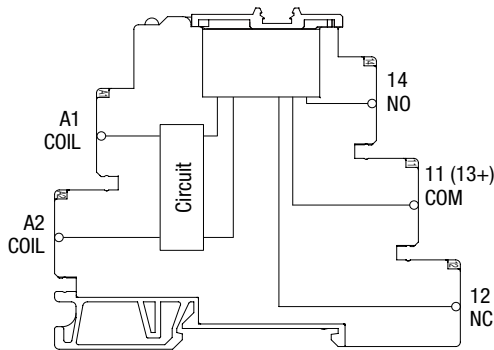

DC

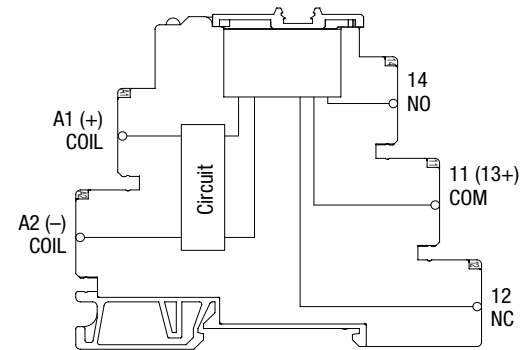

RV1H Internal Connection (bottom view)

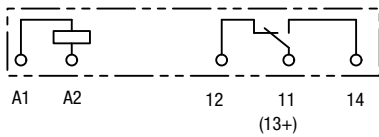

RV8H Internal Connection

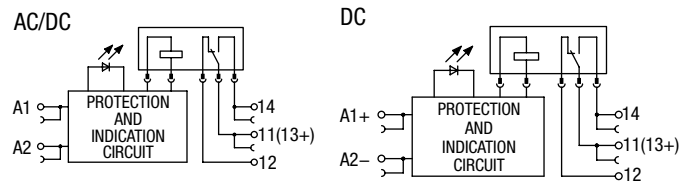

- APEM
- Switches & Pilot Lights
- Control Boxes
- Emergency Stop Switches
- Enabling Switches
- Safety Products
- Explosion Proof
- Terminal Blocks
- Relays & Sockets
- Circuit Protectors
- Power Supplies
- LED Illumination
- Controllers
- Operator Interfaces
- Sensors
- AUTO-ID
- Relays
- Sockets
- DIN Rail Products

- RJ
- RU
- RV8H
- RL

Marking Plate
SV9Z-PW10

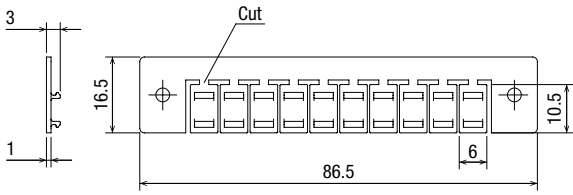

DIN Rail Spacer
SV9Z-SA2W

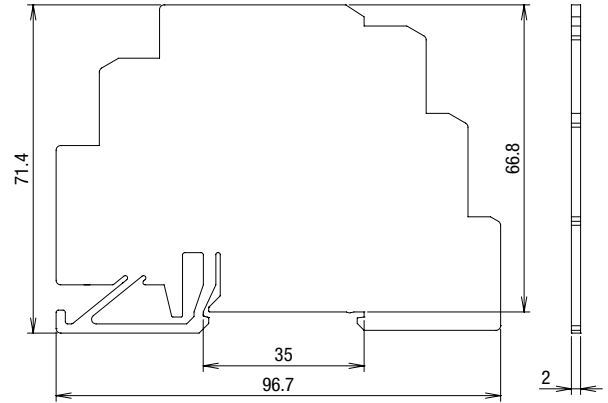

Jumper
SV9Z-J20*PN10

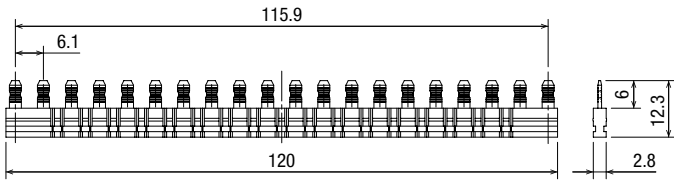

Installing a marking plate

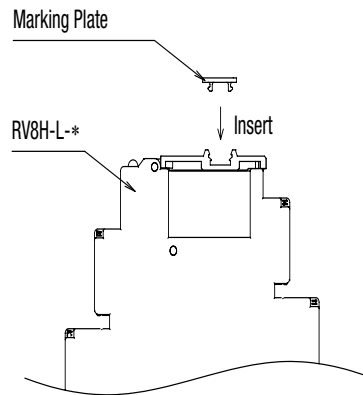

Electrical Life Curve

Resistive Load

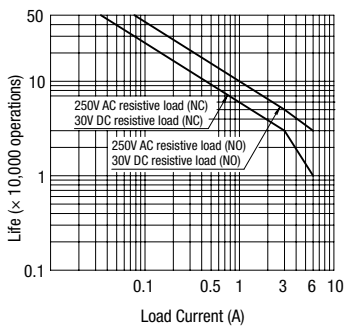

Inductive Load

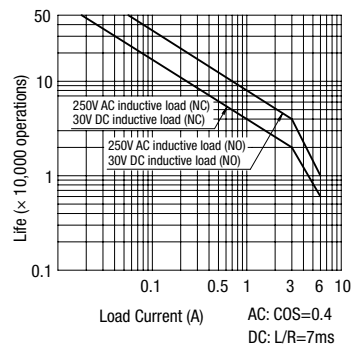

Maximum Switching Current

AC

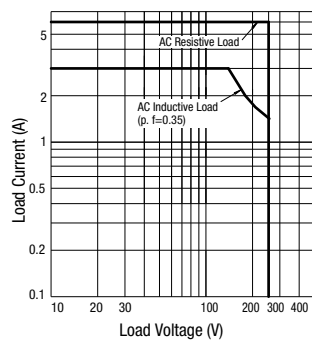

DC

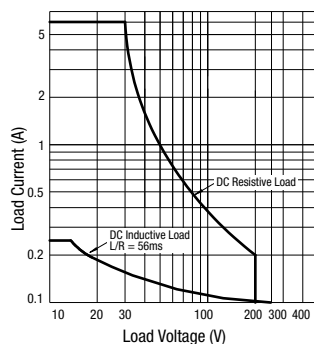

- APEM
- Switches & Pilot Lights
- Control Boxes
- Emergency Stop Switches
- Enabling Switches
- Safety Products
- Explosion Proof
- Terminal Blocks
- Relays & Sockets
- Circuit Protectors
- Power Supplies
- LED Illumination
- Controllers
- Operator Interfaces
- Sensors
- AUTO-ID

Relays

- Sockets
- DIN Rail Products

RJ

RU

RV8H

RL

RV8H Interface Relays

Safety Precautions

- Turn off power before starting installation, removal, wiring, maintenance, and inspection. Failure to turn power off may cause electrical shocks or fire hazard.
- Use proper wires to meet the voltage and current requirements.
- Make sure that relay and output equipment are connected completely. Incomplete connection may cause overheat, resulting in fire hazard.
- To ensure safety, make sure that all descriptions in the operation instructions are followed strictly.
- Prevent metal fragments and pieces of wire from dropping inside the sockets. Ingress of such fragments and chips may cause fire, failure, or malfunction.
- Apply voltage that is applicable to the relay and socket. Otherwise fire, failure, or malfunction will be caused.

Instructions

- Use a 15A non-time delay fuse for protection against short-circuit.
- When lightning surge may enter the input circuit of types AD12, AD18, and AD24, and when lightning surge and noise may enter the input circuit of types AD48 and AD60 of the following products, use a proper varistor. Otherwise, failure may be caused.

Relay	Recommended Varistor
RV8H-L-AD12	Panasonic ERZV07D390
RV8H-L-AD18	
RV8H-L-AD24	
RV8H-L-AD48	Panasonic ERZV14D121
RV8H-L-AD60	
RV8H-S-AD12	
RV8H-S-AD18	
RV8H-S-AD24	
RV8H-S-AD48	Panasonic ERZV14D121
RV8H-S-AD60	

- Observe the maximum ambient temperature shown below. Otherwise, fire, failure, or malfunction will be caused.
- 55°C maximum: RV8H-L-AD110/AD220
RV8H-S-AD110/AD220
- 70°C maximum: All other part nos.

Wiring Instructions

RV8H-L

- Use the following applicable wires for wiring.
2.5mm² max. or AWG14 max., CU (copper), Stranded or Solid wire : 1
1.5mm² max. or AWG16 max., CU (copper), Stranded wire : 2 max.
ø1.3mm max. or AWG16 max., CU(copper) solid wire : 2 max.

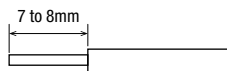

- Strip the wire insulation 7 to 8 mm from the end. Stripping the wire insulation too short may cause the wire to come off. Stripping the wire insulation too long may cause short-circuit with the adjacent socket. Make sure to twist the stranded wire to prevent loosening.
- For wiring, use the following applicable screwdriver.
Phillips screwdriver ø3.5mm max.
Flat screwdriver

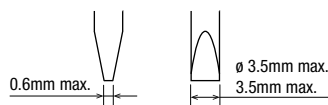

Recommended tightening torque:
0.3 N·m to 0.4 N·m
(UL certificated: 0.35 N·m)

RV8H-S

- Use the following applicable wires for wiring.
0.5mm² to 2.5mm² or AWG20 to AWG14, CU (copper), Stranded or Solid wire: 1

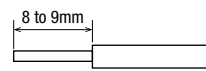

- Strip the wire insulation 8 to 9 mm from the end. Stripping the wire insulation too short may cause the wire to come off. Stripping the wire insulation too long may cause short-circuit with the adjacent socket. Make sure to twist the stranded wire to prevent loosening.
- For wiring, use the following applicable screwdriver. (The shape of the applicable screwdriver is based on DIN5264.)

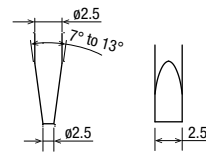

- Wire insertion positions, screwdriver insertion positions, and the directions of screwdriver tip are shown below.

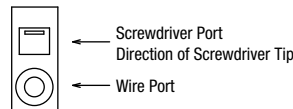

- In applications using ferrules for stranded wires, choose the ferrule listed in the table.

Applicable Wire		Part No.	Manufacturer
mm ²	AWG		
0.5	20	AI0.5-8WH	Phoenix Contact
0.75	18	AI0.75-8GY	
1	18	AI1-8RD	
0.5	22	TE0.5-8	Nichifu
0.75	20	TE0.75-8	
1	18	TE1.0-8	

Instructions

Wiring Instructions

1. Insert an applicable screwdriver into the square-shaped port as shown, until the screwdriver tip touches the bottom of the spring.

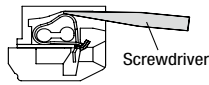

2. Push in the screwdriver until it touches the bottom of the port. The wire port is now open, and the screwdriver is held in place. The screwdriver will not come off even if you release your hand.

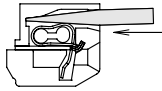

3. While the screwdriver is retained in the port, insert the wire of ferrule into the round-shaped wire port. Each wire port can accommodate one wire or ferrule. When connecting two wires to one terminal, use the adjoining port of the same terminal.

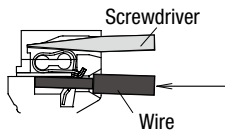

4. Pull out the screwdriver. The connection is now complete.

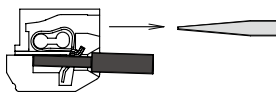

Note: When using wire with insulation diameter or $\phi 2.0\text{mm}$ or less, do not insert the wire too deep where the insulation inserts into the spring clamp opening. Otherwise conductive failure will be caused. Make sure that the wire insulation is stripped 8 to 9 mm and the wire is inserted to the bottom.

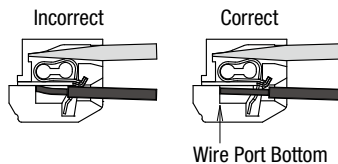

Removing the Relay

- Open the release lever in the direction of the arrow, and remove the relay.

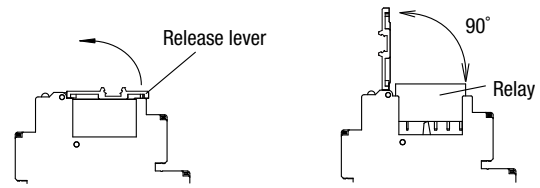

Note 1: The relay may pop out when opening the release lever, resulting in possible damage or loss of the relay. To prevent this, rightly press down the relay using a finger when opening the release lever.

Note 2: Do not open the release lever more than 90° , otherwise the socket will be damaged.

Installing the Relay

- Open the release lever, and insert the relay into the socket until the bottom of relay touches the projection A on the socket. Close the release lever until it is latched.

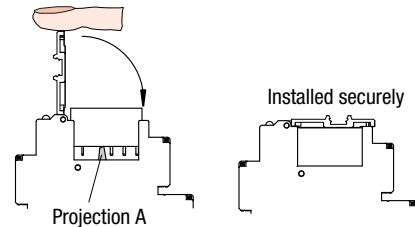

Note: When installing the relay, do not press in using a relay. Make sure to use the release lever, otherwise the projection A will be damaged.

Installing the Socket

- Put the groove on the socket (part B) on the DIN rail, and press the socket towards the DIN rail as shown in the figure.

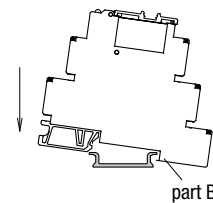

Removing the Socket

- Insert a small flat screwdriver into the slot (part C) of the socket, and pull out the socket as shown in the figure.

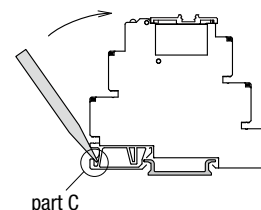

Note: When using the RV8H in cold temperature (0°C or below), install or remove the socket on the mounting rail carefully so that the socket will not be damaged.

APEM

Switches & Pilot Lights

Control Boxes

Emergency Stop Switches

Enabling Switches

Safety Products

Explosion Proof

Terminal Blocks

Relays & Sockets

Circuit Protectors

Power Supplies

LED Illumination

Controllers

Operator Interfaces

Sensors

AUTO-ID

Relays

Sockets

DIN Rail Products

RJ

RU

RV8H

RL

Ordering Terms and Conditions

Thank you for using IDEC Products.

By purchasing products listed in our catalogs, datasheets, and the like (hereinafter referred to as "Catalogs") you agree to be bound by these terms and conditions. Please read and agree to the terms and conditions before placing your order.

1. Notes on contents of Catalogs

- (1) Rated values, performance values, and specification values of IDEC products listed in this Catalog are values acquired under respective conditions in independent testing, and do not guarantee values gained in combined conditions.
Also, durability varies depending on the usage environment and usage conditions.
- (2) Reference data and reference values listed in Catalogs are for reference purposes only, and do not guarantee that the product will always operate appropriately in that range.
- (3) The specifications / appearance and accessories of IDEC products listed in Catalogs are subject to change or termination of sales without notice, for improvement or other reasons.
- (4) The content of Catalogs is subject to change without notice.

2. Note on applications

- (1) If using IDEC products in combination with other products, confirm the applicable laws / regulations and standards.
Also, confirm that IDEC products are compatible with your systems, machines, devices, and the like by using under the actual conditions. IDEC shall bear no liability whatsoever regarding the compatibility with IDEC products.
- (2) The usage examples and application examples listed in Catalogs are for reference purposes only. Therefore, when introducing a product, confirm the performance and safety of the instruments, devices, and the like before use. Furthermore, regarding these examples, IDEC does not grant license to use IDEC products to you, and IDEC offers no warranties regarding the ownership of intellectual property rights or non-infringement upon the intellectual property rights of third parties.
- (3) When using IDEC products, be cautious when implementing the following.
 - i. Use of IDEC products with sufficient allowance for rating and performance
 - ii. Safety design, including redundant design and malfunction prevention design that prevents other danger and damage even in the event that an IDEC product fails
 - iii. Wiring and installation that ensures the IDEC product used in your system, machine, device, or the like can perform and function according to its specifications
- (4) Continuing to use an IDEC product even after the performance has deteriorated can result in abnormal heat, smoke, fires, and the like due to insulation deterioration or the like. Perform periodic maintenance for IDEC products and the systems, machines, devices, and the like in which they are used.
- (5) IDEC products are developed and manufactured as general-purpose products for general industrial products. They are not intended for use in the following applications, and in the event that you use an IDEC product for these applications, unless otherwise agreed upon between you and IDEC, IDEC shall provide no guarantees whatsoever regarding IDEC products.
 - i. Use in applications that require a high degree of safety, including nuclear power control equipment, transportation equipment (railroads / airplanes / ships / vehicles / vehicle instruments, etc.), equipment for use in outer space, elevating equipment, medical instruments, safety devices, or any other equipment, instruments, or the like that could endanger life or human health
 - ii. Use in applications that require a high degree of reliability, such as provision systems for gas / waterworks / electricity, etc., systems that operate continuously for 24 hours, and settlement systems
 - iii. Use in applications where the product may be handled or used deviating from the specifications or conditions / environment listed in the Catalogs, such as equipment used outdoors or applications in environments subject to chemical pollution or electromagnetic interference
If you would like to use IDEC products in the above applications, be sure to consult with an IDEC sales representative.

3. Inspections

We ask that you implement inspections for IDEC products you purchase without delay, as well as thoroughly keep in mind management/maintenance regarding handling of the product before and during the inspection.

4. Warranty

- (1) Warranty period
The warranty period for IDEC products shall be one (1) year after purchase or delivery to the specified location. However, this shall not apply in cases where there is a different specification in the Catalogs or there is another agreement in place between you and IDEC.
- (2) Warranty scope
Should a failure occur in an IDEC product during the above warranty period for reasons attributable to IDEC, then IDEC shall replace or repair that product, free of charge, at the purchase location / delivery location of the product, or an IDEC service base. However, failures caused by the following reasons shall be deemed outside the scope of this warranty.
 - i. The product was handled or used deviating from the conditions / environment listed in the Catalogs
 - ii. The failure was caused by reasons other than an IDEC product
 - iii. Modification or repair was performed by a party other than IDEC
 - iv. The failure was caused by a software program of a party other than IDEC
 - v. The product was used outside of its original purpose
 - vi. Replacement of maintenance parts, installation of accessories, or the like was not performed properly in accordance with the user's manual and Catalogs
 - vii. The failure could not have been predicted with the scientific and technical standards at the time when the product was shipped from IDEC
 - viii. The failure was due to other causes not attributable to IDEC (including cases of force majeure such as natural disasters and other disasters)Furthermore, the warranty described here refers to a warranty on the IDEC product as a unit, and damages induced by the failure of an IDEC product are excluded from this warranty.

5. Limitation of liability

The warranty listed in this Agreement is the full and complete warranty for IDEC products, and IDEC shall bear no liability whatsoever regarding special damages, indirect damages, incidental damages, or passive damages that occurred due to an IDEC product.

6. Service scope

The prices of IDEC products do not include the cost of services, such as dispatching technicians. Therefore, separate fees are required in the following cases.

- (1) Instructions for installation / adjustment and accompaniment at test operation (including creating application software and testing operation, etc.)
- (2) Maintenance inspections, adjustments, and repairs
- (3) Technical instructions and technical training
- (4) Product tests or inspections specified by you

The above content assumes transactions and usage within your region. Please consult with an IDEC sales representative regarding transactions and usage outside of your region. Also, IDEC provides no guarantees whatsoever regarding IDEC products sold outside your region.

IDEC CORPORATION

Head Office 6-64, Nishi-Miyahara-2-Chome, Yodogawa-ku, Osaka 532-0004, Japan

 www.idec.com

USA IDEC Corporation
EMEA APEM SAS

Singapore IDEC Izumi Asia Pte. Ltd.
Thailand IDEC Asia (Thailand) Co., Ltd.
India IDEC Controls India Private Ltd.

China IDEC (Shanghai) Corporation
IDEC Izumi (H.K.) Co., Ltd.
Taiwan IDEC Taiwan Corporation

Japan IDEC Corporation

Specifications and other descriptions in this brochure are subject to change without notice.

2022 IDEC Corporation, All Rights Reserved.

